

CLIPPERCREEK, INC.  
INNOVATIVE INFRASTRUCTURE FOR  
ELECTRIC AND HYBRID VEHICLES



# User's Manual



Model HCS

## **PLEASE NOTE**

This user's manual includes the latest information at the time of printing. ClipperCreek, Inc. reserves the right to make changes to this product without further notice. Changes or modifications to this product by other than an authorized service facility may void the product warranty.

If you have questions about the use of this product, contact your customer service representative. Refer to the Customer Support section located in this guide.

**Please visit ClipperCreek's Website @ [www.clippercreek.com](http://www.clippercreek.com)**

# CONTENTS

IMPORTANT SAFETY INSTRUCTIONS .....	1
ADDITIONAL SAFETY INFORMATION .....	3
FCC INFORMATION .....	4
OPERATION .....	4
THE HCS FRONT PANEL .....	5
INSTALLATION .....	6
SERVICE CONNECTIONS .....	6
MOUNTING PROCEDURES .....	10
WIRING INSTRUCTIONS (Hardwired HCS) .....	14
GROUNDING INSTRUCTIONS .....	15
MOVING & STORAGE INSTRUCTIONS .....	15
MAINTENANCE .....	16
CUSTOMER SUPPORT .....	16
SPECIFICATIONS .....	17
WARRANTY INFORMATION .....	18

## IMPORTANT SAFETY INSTRUCTIONS

Carefully read these instructions and the charging instructions in your vehicle owner's handbook before charging your electric vehicle.

The following symbols may be found in this manual or on labels affixed to the charge station:

**NOTE** *This means pay particular attention.* Notes contain helpful suggestions.

*Cela signifie accorder une attention particulière.* Les remarques contiennent des suggestions utiles.



**CAUTION:** *This symbol means be careful.* You are capable of doing something that might result in damage to equipment.

**ATTENTION:** *Ce symbole signifie être prudent.* Vous êtes capable de faire quelque chose qui pourrait causer des dommages à l'équipement.



**WARNING:** *This symbol means danger.* You are in a situation that could cause bodily injury. Before you work on any electrical equipment, be aware of the hazards involved with electrical circuitry and standard practices for preventing accidents.

**AVERTISSEMENT:** *Ce symbole signifie danger.* Vous êtes dans une situation qui pourrait causer des blessures corporelles. Avant de travailler sur un équipement électrique, être conscient des dangers présentés par les circuits électriques et les pratiques courantes de prévention des accidents.

### Instructions Pertaining to a Risk of Fire or Electric Shock

When using the the HCS, basic electrical safety precautions should be followed:

- Use this charge station to charge electric vehicles equipped with an *SAE-J1772<sup>m</sup> charge port only*. Consult the vehicle owner's manual to determine if the vehicle is equipped with the correct charge port.
- Make certain the charge station *SAE-J1772<sup>m</sup> charge cable* is positioned so it will not be stepped on, tripped over, or otherwise subjected to damage or stress.
- This product contains no user serviceable parts. Consult the Customer Support section in this manual for service information. Do not attempt to repair or service the charge station yourself.
- Do not operate your charge station if it or the *SAE-J1772<sup>m</sup> charge cable* is physically open, cracked, frayed, or otherwise visibly damaged. Contact your Service Representative for service immediately. Consult the Customer Support section in this manual for information on the Service Representative in your area.

- Not for use in commercial garages where a COMMERCIAL GARAGE is defined as a facility (or portion thereof) used for the repair of internal combustion vehicles in which the area may be classified due to flammable vapors being present (such as from gasoline.)
- Do not place fingers inside of the coupler end of the *SAE-J1772<sup>™</sup>* charge cable.
- Do not allow children to operate this device. Adult supervision is mandatory when children are in proximity to a charge station that is in use.

### **Instructions se Rapportant à un Risque d'Incendie ou de Choc Électrique**

Lorsque l'utilisation de la HCS, précautions fondamentale de sécurité électrique doivent être suivies:

- Utilisez cette station de recharge pour charger les véhicules électriques équipés d'un *SAE-J1772<sup>™</sup>* port de recharge seulement. Consultez le manuel du propriétaire du véhicule afin de déterminer si le véhicule est équipé d'un correcte port de recharge.
- Assurez-vous que le *SAE-J1772<sup>™</sup>* câble de recharge sur la station de recharge est positionné de telle sorte qu'il ne sera pas piétiné, accroché plus de, ou autrement endommagé ou de subir le stress.
- Ce produit ne contient aucune pièce réparable par l'utilisateur. Consultez la section Support à la Clientèle dans ce manuel pour obtenir des informations de service. N'essayez pas de réparer ou d'entretenir la station de recharge vous-même.
- Ne faites pas fonctionner votre station ou le câble de recharge si elles sont physiquement ouverte, fissuré, effiloché, ou autrement visiblement endommagé. Contactez votre représentant du service pour service immédiatement. Consultez la section Support à la clientèle dans ce manuel pour obtenir des informations sur le représentant du service dans votre région.
- Ne pas utiliser dans les garages commerciaux où un garage commercial est défini comme une installation (ou une partie) utilisé pour la réparation de véhicules à combustion interne dans lequel la zone peut être classée en raison de vapeurs inflammables étant présents (Tels que de l'essence.)
- Ne posez pas les doigts à l'intérieur de l'extrémité du *SAE-J1772<sup>™</sup>* coupleur du câble de recharge.
- Ne pas laisser les enfants utiliser cet appareil. Supervision d'un adulte est obligatoire lorsque des enfants sont à proximité d'une station de recharge qui est en cours d'utilisation.

## ADDITIONAL SAFETY INFORMATION



**WARNING:** Turn off input power to your charge station at the circuit breaker panel before servicing or cleaning the unit.

**AVERTISSEMENT:** Couper l'alimentation d'entrée à votre station de recharge sur le panneau de disjoncteur avant de nettoyer ou de réparer l'appareil.

**NOTE** **VENTILATION:** Some electric vehicles require an external ventilation system to prevent the accumulation of hazardous or explosive gases when charging indoors. Consult the vehicle owner's manual to determine if your vehicle requires ventilation during indoor charging.

**VENTILATION:** Certains véhicules électriques nécessitent un système de ventilation externe pour éviter l'accumulation de gaz explosifs ou dangereux lors de la charge à l'intérieur. Consultez le manuel du propriétaire du véhicule pour déterminer si votre véhicule nécessite une ventilation quand le recharge en salle.

**NOTE** Vehicles which conform to the *SAE-J1772<sup>m</sup>* standard for communication can inform the charge station that they require an exhaust fan. The HCS is not equipped to control ventilation fans. Do not charge the vehicle with the HCS if ventilation is required.

Véhicules qui sont conformes à la norme *SAE-J1772<sup>m</sup>* de communication peuvent informer la station de recharge qu'ils nécessitent un ventilateur d'extraction. Le HCS n'est pas équipé pour contrôler les ventilateurs. Ne chargez pas le véhicule avec les HCS si la ventilation est nécessaire.



**CAUTION: DO NOT CHARGE** a vehicle indoors if it requires ventilation. Contact your Service Representative for information.

**ATTENTION: NE PAS RECHARGER** un véhicule à l'intérieur si il nécessite une ventilation. Contactez votre représentant de service pour plus d'informations.



**Save these instructions for future reference.**

**Conservez ces instructions pour référence future.**

## FCC INFORMATION

This device complies with Part 15 of the FCC rules. Operation is subject to the following two conditions: (1) This device may not cause harmful interference, and (2) This device must accept any interference received, including interference that may cause undesired operation.

This product has been designed to protect against Radio Frequency Interference (RFI). However there are some instances where high powered radio signals or nearby RF-producing equipment (such as digital phones, RF communications equipment, etc.) could affect operation.

If interference to your charge station is suspected, we suggest the following steps be taken before consulting your ClipperCreek Sales and Service Representative for assistance:

1. Reorient or relocate nearby electrical appliances or equipment during charging.
2. Turn off nearby electrical appliances or equipment during charging.



**CAUTION:** Changes or modifications to this product by other than an authorized service facility may void FCC compliance.

**ATTENTION:** Modifications apportées à ce produit par quiconque autre qu'un centre de service autorisé peut annuler la conformité FCC.

## OPERATION

The HCS Electric Vehicle Charging Station is a compact wall or pedestal-mounted charging station that provides the Plug-in Hybrid or Battery Electric Vehicle (together Plug-In Electric Vehicles, or "PEV") user with a safe and manageable link between the power grid and the PEV. Both hardwired (HCS) and NEMA plug-equipped (HCS-P) versions are available.

The HCS is very easy to use. Just unwrap the *SAE-J1772<sup>m</sup>* charge cable and plug the charge coupler firmly into the vehicle's charge port.

Normally, the vehicle will immediately request a charge using a special communication line in the cable. Within a few seconds the green "Charging" light on the face of the HCS will turn on and the charging cycle will begin. After an average driving day the vehicle battery pack will require several hours to recharge completely. Charging overnight is the most convenient way to maintain healthy batteries and ensure the vehicle's full range will be available for the next day.

When the vehicle has stopped charging the green "Charging" light on the HCS will turn off. To remove the charge coupler once a charge cycle has completed (or to interrupt a charge in progress) press and hold down the latch release lever on the charge coupler handle then unplug the charge coupler from the vehicle charge port.

## THE HCS FRONT PANEL

The front panel on the HCS has four indicator lights:

**POWER** (yellow), indicates that power is available to the HCS.

**CHARGING** (green), indicates that the vehicle is requesting a charge and AC power is currently applied to the vehicle.

**POWER FAULT** (red), indicates that the HCS is not wired correctly. The problem can be due to improper grounding or a missing Earth Ground. The wiring should be examined by a qualified electrician.

**CHARGING FAULT** (red), indicates that the HCS is unable to communicate with the vehicle correctly, or a safety fault condition has been detected by the unit.

Figure 1. Front Panel



Table 1. Front Panel LED Information

#	Amber Power LED	Green Charging LED	Red Power Fault LED	Red Charging Fault LED	Fault Condition
1	off	off	off	off	No power to EVSE. Check circuit breaker.
2	ON	off	off	off	Not plugged into the EV or the EV is not ready to charge.
3	ON	ON	off	off	Charging enabled, power is applied to the vehicle
4	ON	off	ON – not blinking	off	Improper grounding or ground is not present.
5	ON	off	off	ON – not blinking	Problem with EV communications. Disconnect and restart.
6	ON	off	off	blinking	EV ground fault trip. Check vehicle connection.
7	ON	off	blinking	blinking	Internal EVSE fault. Call for service.



# INSTALLATION

## SERVICE CONNECTIONS



**CAUTION:** To reduce the risk of fire, connect only to a circuit provided with the appropriate maximum branch circuit overcurrent protection in accordance with the National Electrical Code, ANSI/NFPA 70 (US) or the Canadian Electric Code C22.2 NO. 280-13 (Canada).

**ATTENTION:** Pour réduire le risque d'incendie, de se connecter uniquement à un circuit fourni avec le approprié circuit de dérivation protection maximale contre les surintensités, en conformité avec le Code National électrique ANSI/NFPA 70 (US) ou Code Canadien de l'électricité C22.2 NO. 280-13 (Canada).

HCS Model HCS Modèle	Circuit Breaker Rating Calibre de Disjoncteur	Receptacle Type Prise Électrique
HCS-40 (hardwired)	40A	n/a
HCS-40P+NEMA 6-50P	50A	NEMA 6-50R
HCS-40P+NEMA 14-50P	50A	NEMA 14-50R
HCS-50P+NEMA 6-50P	50A	NEMA 6-50R
HCS-50P+NEMA 14-50P	50A	NEMA 14-50R
HCS-60 (hardwired)	60A	n/a



**CAUTION: This is a single-phase device. Do not connect all three phases of a 3-phase feed !!!** You may use any two phases of a three-phase wye-transformer feed. The center-point of the three phases (usually used as Neutral) must be grounded somewhere in the system. A Neutral connection is not required by the HCS. Only Line 1, Line 2, and Ground are required, as shown in Figure 3.

**ATTENTION: Il s'agit d'un appareil monophasé. Ne pas relier tous les trois phases d'une alimentation triphasée!!!** Vous pouvez utiliser les deux phases d'un triphasé en étoile transformateur alimentation. Le point central des triphasé (généralement utilisé comme Neutre) doit être mis à la terre quelque part dans le système. Une connexion Neutre n'est pas exigée par la HCS. Seulement ligne 1, ligne 2, et Mise à la Terre sont nécessaires, comme le montre la Figure 3.



**CAUTION:** The two phases used must each measure 120V to Neutral. Earth Ground must be connected to Neutral at only one point, usually at the service entry breaker panel.

**ATTENTION:** Les deux phases utilisées doivent mesurer chaque 120V à Neutre. Mise à la terre doit être connecté au Neutre en un seul point, généralement à l'entrée panneau de disjoncteurs de service.



**CAUTION:** If a 240V 3-phase feed is from a Delta-connected secondary, the leg used must have a center-tap. That tap must be Grounded. Only the two phases on either side of the center-tapped leg can be used. See Figure 4 below.

**ATTENTION:** Si une alimentation à triphasé 240V provient d'un triangle connecté secondaire, la borne utilisée doit avoir un centre-tap. Que la tap doit être Mise à la Terre. Seuls les deux phases l'une ou l'autre côté du centre tapped brancher peut être utilisé. Voir la Figure 4 ci-dessous.



**CAUTION:** Warranty is void if this unit is not wired properly

**ATTENTION:** La garantie est annulée si cette unité n'est pas correctement câblé



**WARNING:** Only a qualified electrician should perform the installation. The installation must be performed in accordance with all local electrical codes and ordinances.

**AVERTISSEMENT:** Seul un électricien qualifié doit effectuer l'installation. L'installation doit être effectuée conformément à tous les codes électriques locaux et des ordonnances.

Only 3 wires are connected, but care must be taken that the service transformer secondary connection is definitely known, and the 3 wires from the main circuit breaker panel are connected and labeled correctly. Figures 2, 3, and 4 below show the most common service transformer secondary wiring formats.

Notice that L1, L2, & Ground are labeled on each diagram. Those transformer outputs correspond to the same inputs on the HCS. Also, each of the two 3-phase diagrams shows an L3 output, which *is not used*. **Do not connect all three phases of a 3-phase secondary to the HCS. This is a single-phase device.**

The Neutral at the service panel must be connected to earth ground somewhere in the system on any of the three connection arrangements. Ground-fault protection is not possible unless the Neutral (center-tap on the service transformer) is connected to an Earth Ground. If no ground is provided by the electrical service, a grounding stake must be driven into the Ground nearby, following local electrical codes. The grounding stake must be connected to the ground bar in the main breaker panel, and Neutral connected to Ground at that point.



**WARNING:** Local electrical codes must always be followed when installing the grounding stake.

**AVERTISSEMENT:** Les codes électriques locaux doivent toujours être respectées lors de l'installation du piquet de mise à la terre.

The following diagrams illustrate the three service transformer secondary connections most common in North America.

Figure 2. 220/240V Single Phase

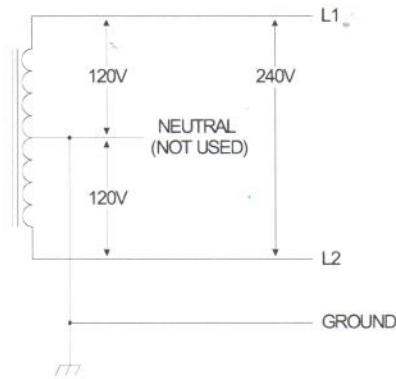
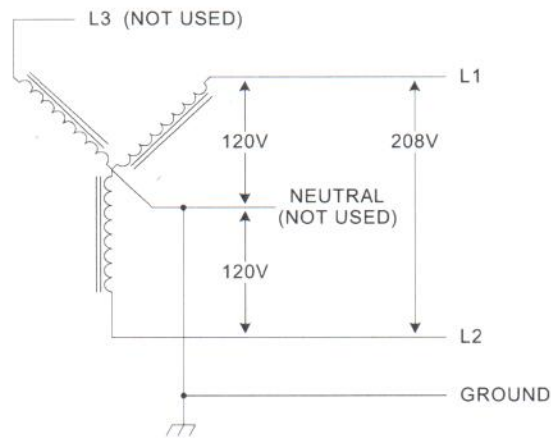

Figure 3. 208V 3-Phase, Wye-Connected



**NOTE** With a wye-connected secondary, any two of the legs can be used to provide 208V to the HCS. For example, L1 & L2, or L1 & L3, or L2 & L3. Leave the unused leg open. Do not connect it to a Neutral bar, or to Ground. Be sure the center point is grounded to Earth somewhere in the system.

Avec un transformateur étoile-connecté secondaire, deux des lignes peut être utilisé pour fournir 208V à la HCS. Par exemple, L1 & L2, ou L1 & L3, ou L2 & L3. Laissez la borne inutilisée ouverte. Ne le connectez pas à un bar Neutre, ou à la Mise à la Terre. Assurez-vous que le point central est Mis à la Terre quelque part dans le système.

Figure 4. 240V 3-Phase, Delta-Connected, with center-tap on one leg.

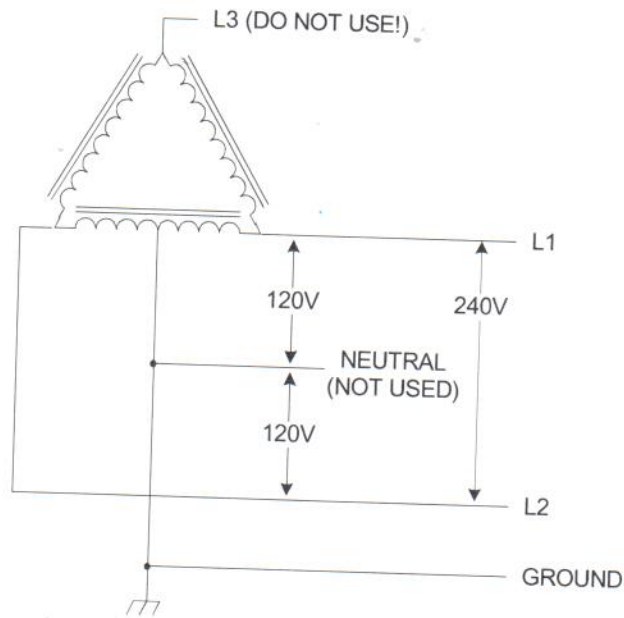

**CAUTION:** With the delta connection, one leg *must* be center-tapped. *Only* the two phases on either side of the center tap can be used. The two phases must *both* measure 120V to Neutral. The third line (L3) of the delta is 208V, with respect to Neutral, and is sometimes referred to as a "stinger". ***Do not use this third line!*** Consult the transformer manufacturer's literature to be sure the single leg can supply the required power.

**ATTENTION:** Avec la connexion triangle, une borne doit être centre-tappée, et seulement les deux phases d'un côté ou de l'autre du centre tap peut être utilisé. Les deux phases doivent mesurer 120V à Neutre. La troisième ligne (L3) du delta est 208V, par rapport à la position Neutre, et il est parfois désigné comme un "stinger". ***Ne pas utiliser ce troisième ligne!*** Consultez la documentation du transformateur fabricant pour être sûr du borne unique peut fournir la puissance requise.



**CAUTION:** A 3-phase delta-connected transformer secondary without a center-tap on one leg *cannot be used with the HCS*. No “Neutral” point is available to be connected to ground for ground-fault protection. The HCS will not allow the contactor to close if it does not sense the presence of a Ground wire connected to a “Neutral” point on the transformer secondary.

**ATTENTION:** Un triphasé triangle-connecté transformateur secondaire sans centre-tap sur le terminal ne peut pas être utilisé avec la HCS. Aucun point "Neutre" est disponible pour être connecté à Mise à la Terre pour protection de défaut à la terre. Le HCS ne permettra pas le contacteur de fermer si elle ne détecte pas la présence d'un fil de Masse connecté à un point "Neutre" sur le secondaire du transformateur.

## MOUNTING PROCEDURES

Locate the wall mounting position of the EVSE:

- On the hardwired HCS, the three service conductors are shielded by three feet of flexible conduit. The HCS must be positioned such that this conduit can reach a nearby service panel or junction box.
- On the plug-in HCS-P, the NEMA plug head is connected by one foot of cable to the bottom side of the HCS-P. The HCS-P must be positioned such that this plug can safely be inserted into a wall-mounted NEMA socket.
- The plug-in HCS-P is intended for indoor use only. Currently, NEMA 14-50 and 6-50 plugs and receptacles are not outdoor rated.
- Position the bottom of the charge station at a comfortable height and at least 18 inches above the ground. Ensure that the LEDs on the front panel of the EVSE can clearly be seen by anyone who will be operating the device.
- The HCS has two vertically aligned mounting holes spaced 17” apart, one each on the enclosure top and bottom. Use a ruler or template to mark hole locations on the mounting surface.



**WARNING:** For safety, always turn off input power to the charge station at the circuit breaker panel prior to plugging it in or wiring it to the service lines. Likewise, turn off the circuit breaker prior to unplugging it or disconnecting the unit from the service lines.

**AVERTISSEMENT:** Pour sécurité, toujours désactiver le courant d'entrée de la station de recharge au niveau du disjoncteur du panneau avant de le brancher ou de câblage à les lignes de service. De même, coupez le disjoncteur avant de le débrancher ou déconnecter l'unité à partir des lignes de services.

## For Hollow-Wall Construction:

- Place the unit such that both mounting holes can take advantage of solid structural framing inside of the wall or a strong wall surface such as plywood.
- Size  $\frac{1}{4}$ -20 lag screws are recommended for mounting the HCS to a wooden structure. Pre-drill appropriately sized pilot holes to allow the lag screw to grip the wooden structure while preventing the wood from cracking or splintering while the screw is fastened.
- The included plastic angle washers can be oriented to allow the lag screws to be fastened at an angle while still providing a solid flat backing to the screw head.
- If the screw head is smaller than the  $\frac{3}{8}$ " washer aperture, an additional flat washer will need to be placed between the plastic angle washer and the head of the lag screw.
- If either mounting hole does not have a solid mounting structure (such as drywall without a solid backing) it will be necessary to use proper anchoring hardware such as drywall toggles or molly bolts.

Figure 5. Mounting the HCS to a hollow wall

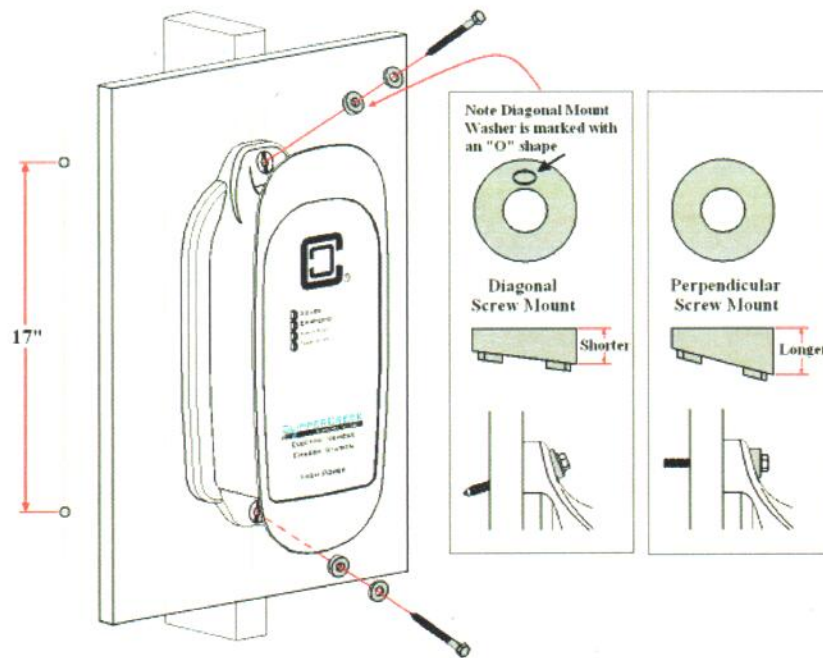

## For Solid-Wall Construction:

- To secure the unit in concrete, pre-drill appropriately sized holes and use multi-set or wedge anchor hardware at both mounting points.
- To secure the unit in brick or stone, pre-drill appropriately sized holes and use sleeve anchors at both mounting points.
- The included plastic angle washers can be oriented to allow bolts to be fastened either at an angle or perpendicular to the mounting surface. Note there are two different sets of plastic angle washers included. Select those washers that best accommodate the mounting hardware "angle of attack" and orient them accordingly.
- Note that if the head of the mounting hardware is smaller than the 3/8" plastic angle washer aperture, an additional flat washer will need to be placed between the plastic angle washer and the mounting hardware.
- Machine screw size 1/4-20 hardware is recommended for mounting the HCS. Screw shafts of at least 2" are recommended. The HCS plastic angle washer hole size is 3/8" in diameter, so ensure that the screw heads are of a larger diameter. Place appropriately sized washers between the screw heads and the HCS enclosure mounting flanges.

Figure 6. Mounting the HCS to a solid wall

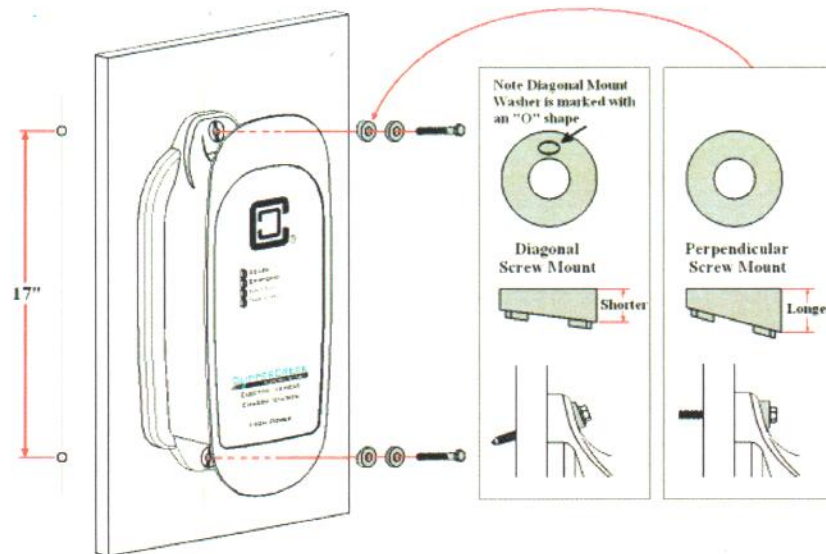

## Mounting the *SAE-J1772<sup>™</sup>* Connector Holster

The *SAE-J1772<sup>™</sup>* connector holster is an available option to provide a convenient protective housing for the the *SAE-J1772<sup>™</sup>* connector head when it is not in use.

- The *SAE-J1772<sup>™</sup>* connector holster should be placed so that users have easy and safe access to the *SAE-J1772<sup>™</sup>* connector.
- For indoor installation, mount the *SAE-J1772<sup>™</sup>* connector holster between 18 and 48 inches above the ground or grade.
- For outdoor installation, mount the *SAE-J1772<sup>™</sup>* connector holster between 24 and 48 inches above the ground or grade.
- The *SAE-J1772<sup>™</sup>* connector holster has two vertically aligned mounting holes spaced 5.45" apart, one each on the enclosure top and bottom. Use a ruler or template to mark hole locations on the mounting surface.
- The vertical alignment of the HCS and *SAE-J1772<sup>™</sup>* connector holster mounting holes allows for the convenient mounting of both components onto the same post or wall structure. For example, the holster may be mounted directly above the HCS.
- Place the *SAE-J1772<sup>™</sup>* connector holster such that both mounting holes can take advantage of solid structural framing inside of the wall or a strong wall surface such as plywood.
- A set of exterior wood screws and stainless steel washers are included for the purposes of mounting the *SAE-J1772<sup>™</sup>* connector holster to a wooden surface.
- For mounting to a solid surface such as concrete, brick, or stone, alternate hardware may need to be procured. Examples of solid-wall mounting hardware include multi-sets, wedge anchors and sleeve anchors. Use the type of mounting hardware most appropriate for the supporting structure.

Figure 7. Mounting the holster using the exterior wood screws and washers

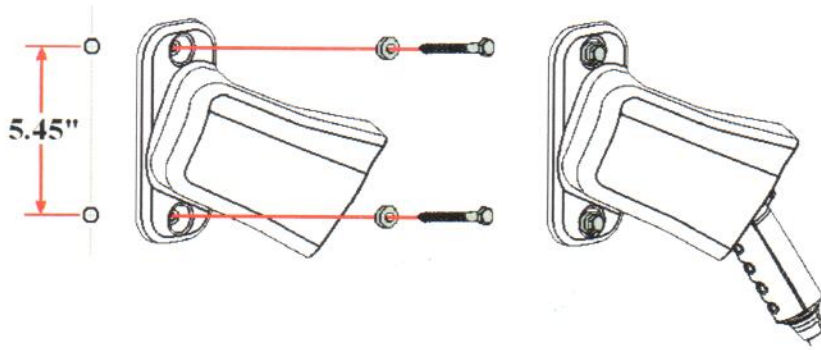



## WIRING INSTRUCTIONS (Hardwired HCS)

Route the HCS conduit to a nearby service panel or junction box. Use the included ½" trade size watertight fitting and sealing washer to provide a moisture-resistant seal with the service panel or junction box. If necessary, drill a 7/8" diameter hole to accommodate the liquid-tight fitting.

Figure 8. Wiring the HCS in a junction box

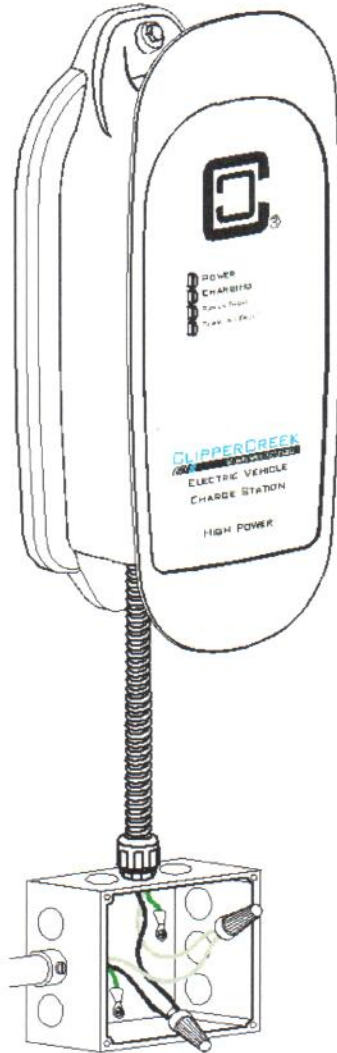

### NOTE

Before connecting the HCS service conductors, please carefully read the section of this manual titled Service Connections on page 6. If you are unsure of the type of power provided at the service panel, please consult with your local utility or call your Service Representative for assistance.

### NOTE

The three HCS-40 service conductors use stranded 10AWG, 75°C copper wire. The insulation of each conductor is color coded for standard 240VAC installation:

Green: Ground  
 Black: Line 1 (120VAC to Ground)  
 Red: Line 2 (120VAC to Ground)

Les trois conducteurs service la HCS-40 utiliser multibrins 10 AWG, 75°C fil de cuivre. L'isolation de chaque conducteur est un code couleur pour une installation standard de 240 V CA:

Vert: Mise à la Terre  
 Noir: Ligne 1 (120VAC à Mise à la Terre)  
 Rouge: Ligne 2 (120VAC à Mise à la Terre)

## GROUNDING INSTRUCTIONS

This product must be grounded. If this product should malfunction or break down, grounding provides a path of least resistance for electric current to reduce the risk of electric shock.

### For the hardwired HCS:

The hardwired HCS is equipped with three service conductors shielded by three feet of flexible conduit. This product must be connected to a grounded, metal, permanent wiring system, or an equipment-grounding conductor must be run with the circuit conductors and connected to the ground lead on the product.

### For the plug-in HCS-P:

The plug-in HCS-P is equipped with a cord having an equipment grounding conductor and a grounding plug. The plug must be plugged into an appropriate outlet that is properly installed and grounded in accordance with all local codes and ordinances.



**WARNING:** Improper connection of the equipment-grounding conductor may result in a risk of electric shock. Check with a qualified electrician if doubt exists as to whether the product is properly grounded. Do not modify the plug provided with the product – if it will not fit the outlet, have a proper outlet installed by a qualified electrician.

**AVERTISSEMENT:** Une mauvaise connexion du conducteur de terre peut entraîner un risque de choc électrique. Vérifier avec un électricien qualifié si il existe un doute quant à savoir si le produit est correctement mis à la terre. Ne pas modifier la fiche fournie avec le produit – si elle n'entre pas dans la prise, faites installer une prise adéquate par un électricien qualifié.

## MOVING & STORAGE INSTRUCTIONS

Note that both the hardwired HCS and the plug-in HCS-P are intended for fixed installations. For mounting requirements, consult the *Mounting Procedures* section of the *Installation Instructions* in this manual.

Always turn off input power to the charge station at the circuit breaker panel prior to hard-wiring an HCS to or disconnecting an HCS from the service lines.

Likewise, always turn off input power to the charge station at the circuit breaker panel prior to plugging an HCS-P into or unplugging an HCS-P from a NEMA socket.

When transporting the charge station, do not lift or carry the entire unit by the *SAE-J1772<sup>m</sup>* charge cord. Likewise, do not lift or carry the entire unit by the flexible conduit and input conductors (HCS) or the NEMA plug (HCS-P).

The charge station has a non-operational storage temperature range of -40°C to +80°C (-40°F to +176°F).

## MAINTENANCE

The HCS requires no periodic maintenance other than occasional cleaning.



**WARNING:** To reduce the risk of electrical shock or equipment damage, exercise caution while cleaning the unit and the EV charge connector cable.

1. Turn off the charge station at the circuit breaker before cleaning.
2. Clean the charge station using a soft cloth lightly moistened with mild detergent solution. Never use any type of abrasive pad, scouring powder, or flammable solvents such as alcohol or benzene.



**AVERTISSEMENT:** Pour réduire le risque de choc électrique ou des dommages équipement, user de prudence lors du nettoyage de l'appareil et le câble du connecteur de charge EV.

1. Eteignez la équipement au disjoncteur avant de le nettoyer.
2. Nettoyez l'équipement à l'aide d'un chiffon doux légèrement humidifié avec une solution de détergent doux. Ne jamais utiliser de tampons abrasifs, de poudre à récurer ou de solvants inflammables tels que l'alcool ou le benzène.

## CUSTOMER SUPPORT

Call your ClipperCreek, Inc. Service Representative at any time, 24 hours a day, at the number below. **PLEASE HAVE THE MODEL NUMBER AND SERIAL NUMBER AVAILABLE WHEN YOU CALL.** This information is printed on the label on the left side of the HCS enclosure. If your call is made after business hours or on weekends, please leave your name, telephone number, the unit serial number, and a brief description of the problem. A Service Representative will call back at the earliest opportunity.

**Distributor Service  
Number Here**

**To contact ClipperCreek, Inc. directly for service, call (530) 887-1674 from Monday to Friday between 8:00 am and 5:00 pm Pacific Standard Time.**

# SPECIFICATIONS

## Line Input Power

### Voltage & Wiring

240V AC single-phase - L1, L2, and Safety Ground.

208V AC 3-phase wye-connected - Any two phases and Safety Ground.

240V AC 3-phase, delta-connected. With center-tap on one leg, must use only the two phases on either side of the center-tap. The two phases must both measure 120V AC to ground. **Do not use the third leg (208V "Stinger").**

### Service Conductors

HCS-40 and HCS-40P: L1, L2 and Ground use 10AWG, 75°C copper wire.

HCS-50P and HCS-60: L1, L2 and Ground use 8AWG, 75°C copper wire.

### Voltage Range:

185V AC to 264V AC

### Frequency

60 Hz

## Current &

### Output Power (at 240VAC)

HCS Model Number	Circuit Breaker	Maximum Current	Output Power
HCS-40	40A	30A	7.2 KW
HCS-40P + 6-50P	50A	30A	7.2 KW
HCS-40P + 14-50P	50A	30A	7.2 KW
HCS-50P + 6-50P	50A	40A	9.6 KW
HCS-50P + 14-50P	50A	40A	9.6 KW
HCS-60	60A	48A	11.5 KW

Note that the maximum current for the vehicle is set by the duty cycle of the Pilot waveform.

Output power is variable depending upon the HCS model and vehicle demand.

## Plugs

Attached NEMA 6-50P and NEMA 14-50P plugs are available on the HCS-40P and HCS-50P.

## Dimensions

Dimensions are for the enclosure only:

Height: 500 mm (19.7 inches)

Width: 225 mm ( 8.9 inches)

Depth: 135 mm ( 5.3 inches)

## Weight

HCS-40 or HCS-40P with 30A *SAE-J1772<sup>™</sup>* connector and 25' length of cable: 6.0kg (13 lbs)

HCS-50P with 65A *SAE-J1772<sup>™</sup>* connector and 25' length of cable: 8.5kg (19 lbs)

HCS-60 with 65A *SAE-J1772<sup>™</sup>* connector and 25' length of cable: 9.0 kg (20 lbs)

## Environment

Operating Temperature: -30°C to +50°C (-22°F to +122°F)

Storage Temperature: -40°C to +80°C (-40°F to +176°F)

Enclosure Rating: NEMA 4 - watertight

## Agency Approvals

ETL Listed, FCC Part 15 Class B

## WARRANTY INFORMATION

### LIMITED WARRANTY ELECTRIC VEHICLE SUPPLY EQUIPMENT and ACCESSORIES

ClipperCreek, Inc.  
11850 Kemper Road  
Auburn, California 95603  
Phone: 530-887-1674  
Email: [information@clippercreek.net](mailto:information@clippercreek.net)

ClipperCreek shall provide the following warranty with respect to the Products to Representative, its Sub-Representatives and their customers:

#### **Product 3-year parts, 3-year factory labor:**

ClipperCreek, Inc. warrants this product to be free from defects in material and workmanship. The warranty period shall commence on the date of installation date (first use). The product installation date must be evidenced and communicated to ClipperCreek by way of the warranty registration card (or its equivalent). The warranty registration card must be filled out completely and accurately, and returned to ClipperCreek within 30 days after installation, and the product installation date shall be within 6 months after the purchase date. If a Product installation date is not communicated to ClipperCreek as described above, the product purchase date shall serve as the warranty commencement date.

If this product is defective in materials or workmanship during the warranty period, ClipperCreek will, at its option, repair or replace the product. Repair parts and/or replacement products may be either new or reconditioned at ClipperCreek's discretion. This limited warranty does not cover service or parts to repair damage due to improper installation or use, including but not limited to improper connections with peripherals, external electrical faults, accident, disaster, misuse, abuse or modifications to the product not approved in writing by ClipperCreek. Any service repair outside the scope of this limited warranty shall be at applicable rates and terms then in effect. This warranty covers factory parts and factory labor only; it does not cover field service or removal and replacement of the product or any other costs.

All other express and implied warranties for this product including the warranties of merchantability and fitness for a particular purpose are hereby disclaimed. Some states do not allow the exclusion of implied warranties or limitations on how long an implied warranty lasts, so the above limitation may not apply to you. If this product is not as warranted above, your sole and exclusive remedy shall be repair or replacement as provided above. In no event will ClipperCreek, any of its authorized sales and service representatives, or its parent company be liable to customer or any third party for any damages in excess of the purchase price of the product. This limitation applies to damages of any kind including any direct or indirect damages, lost profits, lost saving or other special, incidental, exemplary or consequential damages whether for breach of contract, tort or otherwise or whether arising out of the use of or inability to use the product, even if ClipperCreek or an authorized ClipperCreek representative or dealer has been advised of the possibility of such damages or of any claim by any other party. Some states do not allow the exclusion or limitation of incidental damages for some products, so the above limitation or exclusion may not apply to you. This warranty gives you specific legal rights, and you may also have other rights which may vary from state to state.

#### **To obtain warranty service:**

Call your nearest authorized Service Representative or ClipperCreek at the above number. You will receive information as to how service for the product will be provided. If you mail or ship the product in for service, you must insure the product, prepay all shipping charges, and properly pack it for shipment in its original shipping container or its equivalent. You are responsible for all loss or damage that may occur in transit. You must provide proof of purchase of the product and the purchase date before any warranty service can be performed.



CLIPPERCREEK, INC.  
11850 KEMPER RD., SUITE E  
AUBURN, CA 95603  
[WWW.CLIPPERCREEK.NET](http://WWW.CLIPPERCREEK.NET)